

WARNING!
Safety Information

Your pool is designed for years of pleasurable, safe family fun. But when used incorrectly, a swimming pool can be dangerous. To insure your pool is used safely, you **MUST** observe the following safety precautions:

- Do not dive!- Do not jump!-No rough play!- no running or pushing.
- Do not walk on the top rail. It can be slippery & is not a walkway.
- Be sure to install all safety labels provided with your pool according to the instructions.
- Keep a safety rope 1/4" by 50' with a floatation buoy with an outside diameter of 15". Have accessible in prominent area by your pool.
- Post near all entrances to the pool area a list of phone numbers of the:
 - Nearest available police
 - Nearest available fire department
 - Nearest available rescue unit
 - 911 emergency number if available
 - Nearest ambulance service
 - Nearest available hospital
 - Nearest available physician
- Provide fencing or enclosure, which is independent of the house as a closure around the entire pool area. The fence must be made of durable material to make pool inaccessible to toddlers and uninvited guests.
- Make sure gate is always closed, Be sure to follow local building code requirements for load capacity and fencing.

- Check with your local town for any special laws in your locale.
- Never drink alcoholic beverages or use any intoxicants, which could hinder your judgment or reflexes.
- Never use pool alone. All children must be supervised continuously.
- Do not use pool if bottom is not clearly visible: At night sufficient lighting must be available. It is the pool owner's sole responsibility to provide adequate lighting for pool bottom, safety signs and walkways, which exceed the standards of the EIS of North America.
- Do not climb, stand or sit on any pool structure or the filter system. Components such as the filtration system, pumps, and heater must be positioned so as to prevent their being used as a means of access to the pool by young children.
- Be sure that all toys, chairs and tables or similar objects that a young child could climb on are at least 4 feet away from pool.
- Do not use pool during electrical or rain storms
- See available National Spa and Pool Institute (NSPI), publications for more tips on pool safety.

IMPORTANT NOTICE!
READ BEFORE INSTALLATION

The safety stickers must be installed as per following instructions. Failure to properly install warning labels will void warranty. **Failure to mount these safety labels may subject you to substantial liability in case of injury.**

WARNING!
Safety Information

Notice to Pool Owners and Installers

These warnings are not to be removed under any circumstances!
 If they fall off or become discolored please request replacements, which will be sent at no charge.

Practical pool safety- These labels and your cooperation may save a life!
 In addition, failure to mount these instructions may subject you to substantial liability in case of injury.



For placement, the sign must be visible from all possible access to pool.

If more are needed write for additional signs at no charge.

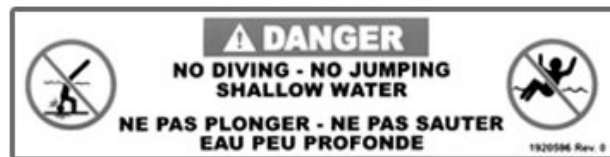

Signs are for placement on liner and on top seats.
 Signs are supplied with the liner and with the pool in hardware kit. Place above the water line, located at equal points away from ladder.

INSTRUCTION SHEET FOR AQUA LEADER POOLS

Thank you for choosing AQUA LEADER and congratulations on your new pool purchase! You must make a preliminary study of this instruction booklet to familiarize yourself with all that is involved with the installation, and to get a thorough understanding of the step-by-step procedures you are about to follow. If you do not follow this instruction booklet thoroughly, you may damage your pool or property and void your warranty. (Refer to your warranty for complete details on conditions and limitations).

Again, thank you for choosing Aqua Leader, and we wish you many safe and pleasant summers!

Plan your installation

Before you begin, make sure your installation meets all municipal regulations and local codes related to above ground pool installations. Be sure to check the local laws regarding construction and electrical installations and, make sure your pool is installed to conform to all security regulations related to pool fencing and covers.

Important

Above ground pools are not designed to be installed below the surface. Outside ground forces can collapse the pool wall. If you hire a professional installer, this installation booklet must be followed. AQUA LEADER INC. will not be responsible for improper installation.

Before you begin

Make sure you have all of the necessary parts and equipment to assemble and install your pool. (See the Parts List in your pool specific instruction sheet) If you find irregularities such as missing or defective parts see your Aqua Leader authorized dealer for replacements.

Necessary tools for assembly

- Measuring tape
- Nails
- Heavy string
- Adjustable spanner
- Tamping tool
- Garden rake
- Shovel
- Wood stake
- Clothespins 3" long
- Optical level
- Sod cutter
- Steel rods
- Grass roller
- Felt tip pen
- Hammer
- Carpenter saw
- Knife
- 2' carpenter level
- Screwdriver (philips)
- String level
- 2" heavy fabric tape
- Pliers
- Vacuum cleaner (industrial)
- Carpenter nails
- Pipe wrench

▶ STEP 1: SITE PREPARATION

STEP 1.1: AREA PREPARATION

To select an appropriate site, consider the following:

- Distance from the fence
- Accessory location (filter, decking, power source, etc.)
- Electrical outlets
- Weeded areas
- Overhead electrical wires
- Surrounding trees (roots and falling leaves)
- Sun reflection
- Underground cables and gas conduits
- Prevailing winds



* **NOTE 1:** Do not install your pool on concrete, asphalt, wood, grass, turf, gravel or chemically treated soil. Do not install your pool on windy days. Ensure that you at least 3 or more helpers.

* **NOTE 2:** It is extremely important that the ground surface is firm and level, and that the pool site is free of grass, rocks, roots, or any sharp objects. Any parcel of grass left under the pool will rot and may release an unpleasant odor.

* **NOTE 3:** Avoid installing your pool on surfaces that have been treated with oil, weed killer or chemical products as this could adversely affect your pool installation and damage the liner.

The entire pool surface must be completely leveled. Do not fill the lower ground area, as any added ground will not provide the strength needed to support the weight of the pool.

⊘ **ATTENTION!** *Aqua Leader* is not responsible for any damages to your pool if it is not installed according to the installation instructions. Installing your pool on soft or non-leveled ground will void the warranty.



STEP 1.2: GROUND SURFACE AND LEVELNESS

After choosing for the best location on your site, you can start the installation.

□ **1.2.1:** Once you have decided on the best location, mark where the center of the pool will be by pushing a steel rod into the ground.

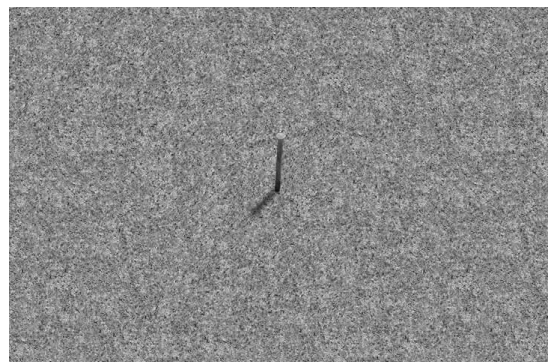

□ **1.2.2:** With a measure tape and spray paint, trace a circle whose radius measure 12 inches larger than the pool.

See the **ANNEX – DIAMETER TABLE** to determine the actual diameter of the pool.

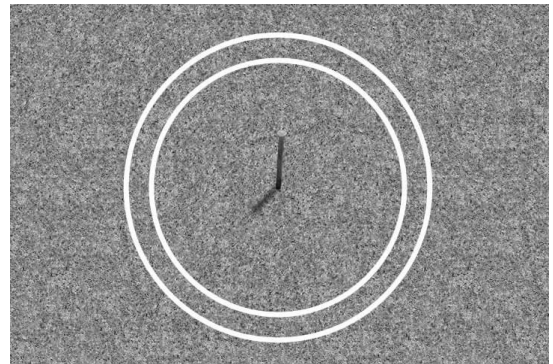

□ **1.2.3:** Remove the grass inside the circle with a sod cutter.



□ **1.2.4:** Level the site using a shovel, a rake and an optical level. Remove all high spots and level to the lowest point within the boundaries. **DO NOT ADD ANY SOIL TO THE SITE!** Added soil will not provide the strength required to support the weight of the pool. The ground must always be firm. The entire bottom must be smooth and free of stones, sticks and any other foreign materials that could puncture the liner.



□ **1.2.4-B: IMPORTANT - FROST:** In area where the ground freeze or the drainage is deficient, we recommend to **add 2 inches of crushed stone by 18 inches width**. This band of crushed stone has to be leveled and compacted and has to lie underneath the pool wall.

□ **1.2.5:** Retrace the pool circle.

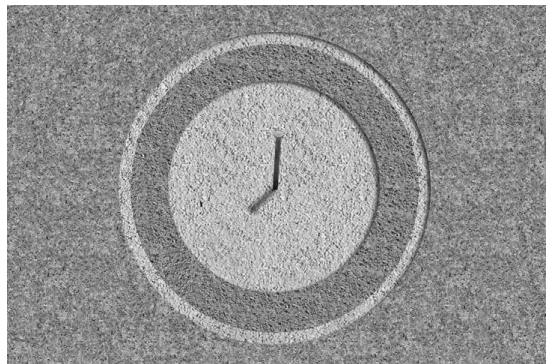

* **NOTE 1:** Do not remove the steel rod at the center of the pool.

* **NOTE 2:** *Aqua Leader* is not responsible for any damages to your pool if it is not installed according to the installation instructions. Installing your pool on soft or non-leveled ground will void the warranty.

▶ STEP 2: Bottom wall channel and bottom plate

□ 2.1: Place the bottom wall channels and bottom plates in a circle.

* **NOTE:** During installation, the curves and length of the bottom wall channels will help to position the bottom plates.

□ 2.2 : Install the round bottom wall channel into the bottom plate. Do not insert the bottom wall channels too deep into the bottom plate, at this time. Leave a ¼” to ½” between the bottom wall channel and the bottom plate.



□ 2.3: At this stage, it is important to verify that the circle is round. Use a rope with the center rod as in step 1.2.2.

□ 2.4: Verify the height of each bottom plate with an optical level. They have to be at the same height. Adjust height if necessary.



□ 2.5: Once the verification is done, plant a steel rod or a large nail on the outside edge of the bottom wall channel. Some bottom wall channels carry a hole to receive a metal rod or a nail.

* **NOTE:** If you install a geotextile (felt) liner protection for the bottom, you need to apply sand or crushed stone underneath the geotextile (felt). **Do not put crushed stone directly under the liner.**

□ 2.6: Before installing the last bottom wall channel, enter enough sand to fill the bottom of the pool and to build a cove. Put the sand in the middle of the pool area.



* **NOTE:** A layer of 2 inches of sand is necessary to protect the liner from small rocks and pebbles. Consider enough sand to build the cove as well.

▶ STEP 3: WALL INSTALLATION

Measure

□ **3.1:** Before installing the wall, use a flexible tape measure to measure the perimeter of the wall. Measure by inserting the tape measure into the **bottom wall channels** around the pool and compare it with the table **PART LIST** in the **ANNEX** under the name **Steel wall (Hole-to-Hole)**.

* **NOTE 1:** If the measure is smaller than the length of the wall, distance the bottom wall channels in the bottom joining plates (round section). If the measure is greater than the wall, close the distance of the bottom wall channels in the bottom joining plates (round section).

Installation

* **NOTE 1:** During installation, make sure the wall in the round section is held in place using rope and stakes planted in the ground. Also, install top wall channels temporarily to keep the wall in place.

* **NOTE 2:** The wall installation starts where the water return and the skimmer are to be placed. In addition, it is important to start the wall installation on a **bottom plate**, when the wall is closed a **support post** will hide the wall junction.

* **NOTE 3:** Also, you need to carry sand in the middle of the pool if you plan to build a cove and bottom protection for the pool.

□ **3.2:** Put the wall on a solid surface to facilitate unfolding.



□ **3.3:** Insert the wall starting in the center of a **bottom joining plate**.

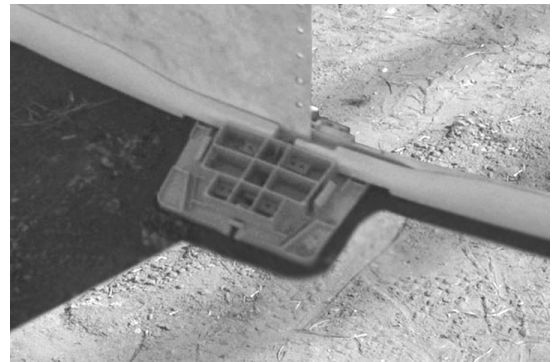

□ **3.4:** With the assistance of at least 3 people, unroll the wall so that the painted pattern faces the outside of the pool and that the pre-punched opening for the skimmer is on the top.



□ **3.5:** Guide the wall in the **bottom wall channels** until both ends meet.

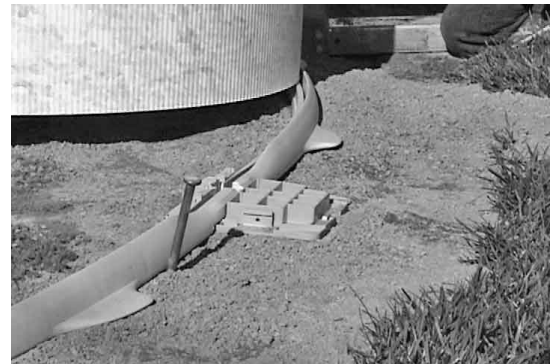

□ **3.6:** As you unroll the wall, install **top wall channels** around the pool to give it more rigidity during installation. Ensure that the **top wall channels** are aligned with the **bottom wall channels**. To ensure a better stability of the wall during installation, use ropes, hooks and steel rods.



Closing the wall

□ **3.7:** Overlay the two joints of the wall so that the aluminum bars can be found on both the interior and exterior of the pool.

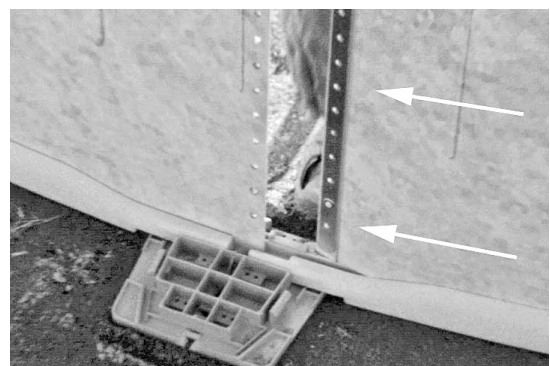

⊘ ATTENTION! If the two ends of the wall do not overlap, tap lightly on each **bottom joining plate** on the inside. If the wall overlaps too much, tap lightly on each **bottom joining plate** on the outside. You will modify slightly the circumference of the wall to enable it to fit perfectly. The bottom wall channel should be of equal distance in all bottom junction plate. **When the two ends of the wall overlap, ensure that the aluminum bars are placed in the interior and exterior of the pool.**

□ **3.8:** Install the bolts and nuts into each hole (the quantity of screws corresponds to the amount of holes).



Wall with aluminum bars

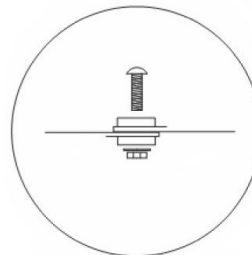
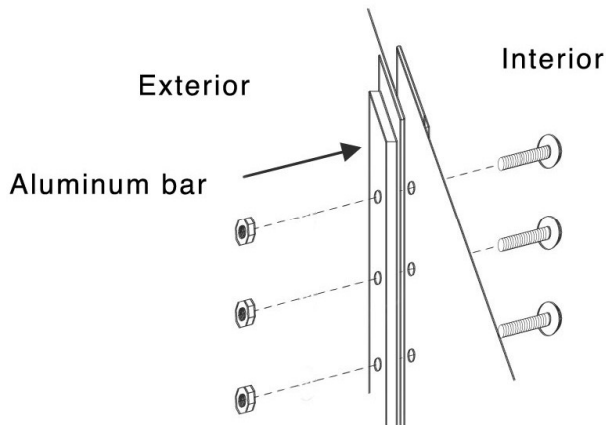

Correct

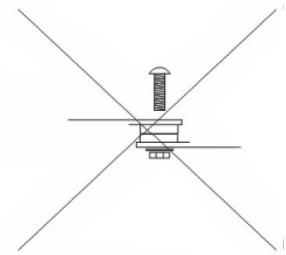

Wrong

Warranty is void if the aluminum bars are not used!

IMPORTANT! All holes of the aluminum bars must be filled

□ **3.9:** Make sure that the bolt heads are on the interior side of the pool.

IMPORTANT REMINDER!

Due to the enormous pressure exerted against the pool wall, it is essential to screw in all bolts tightly.

- Begin at the bottom of the wall and work up.
- Every holes covered by the aluminum bar must be used.
- Make sure the pool wall is resting securely in the bottom of the wall channels and it makes a perfect circle.
- Bolt heads must be on the interior, and nuts and washers on the exterior.
- File off any burrs, and cover all bolt heads with a heavy fabric tape before putting on the vinyl liner.



□ **3.10: Verification**

At this stage, it is very important to take measures after the installation of the wall as the parameters are likely to have changed.

□ **3.11:** Attach a rope to the steel rod in the middle of the pool.

□ **3.12:** Pull the rope to the wall keeping the rope under tension, measuring the curve from one side of the pool to the other side. If the **bottom joining plate** and the **bottom wall channel** are not in the circle, take time to adjust.

▶ **Step 4: Support post installation**

□ 4.1: Insert the base of the support post into the bottom plate until the hooks snaps.



▶ Step 5: POOL BOTTOM AND COVE

Step 5.1: Pool bottom

Sand

□ 5.1.1 - A: Apply sand (2 inches) on the ground, then level and compact.

* **Note:** Do not to use all the sand, keep a certain quantity to build the cove.



OPTIONAL

Felt (Geotextile)

□ 5.1.1 – B1: Unroll the felt on the ground. Felt should be wider than the surface of the pool.



□ 5.1.1 – B2: Cut the felt along the base of the wall.

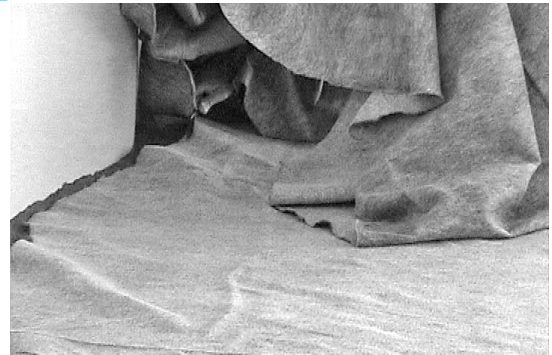

Cove

* **NOTE:** The cove is necessary to prevent the liner from creeping underneath the wall. *Aqua Leader* will decline any liability for damages if this step is omitted. Use only humid screened soil. Do not use thin sand, grass, turf or any product identified as “pool base” as these products can cause damage to the liner. (You can use COMPACTED SIFTED EARTH COVE or PRE-FORMED COVE – available through your dealer).

Sand cove

□ 5.1.2 - A: Make sure that the cove is at least 3 inches high along the wall and ends in a gentle slope towards the interior of the pool. Be sure to compact the sand and remove any small stones.



OR

Styrofoam cove

□ 5.1.2 – B: Place the preformed cove around the base of the pool wall. Use duct tape to attach the cove along the wall.



Step 5.2: LINER INSTALLATION

□ 5.2.1: Place the folded liner in the center of the pool. Unfold the liner making sure that the printed texture is facing up. Also bring the bottom seam along the base of the pool wall, once extended the liner should be at +/- 4 inches from the wall (remove shoes to avoid damaging the liner).



IMPORTANT :

Do not cut skimmer and return holes until there is 2 feet (60 cm) of water in the pool.)

Step 5.2.2 - A: Beaded liners and “snap-in” installation

If you don't have this type of liner, [jump to the next section!](#)

□ 5.2.2 - A1: Remove the **top wall channels** one section at a time.



5.2.2 - A2: Bead liner

Hang the bead of the liner at the top of the wall. As the bead is installed, place the top wall channel and ensure that the channels are centered in the middle of the posts.



“Snap-In” liner

For a “snap-in” liner, the bead hook is inserted into the groove, which is designed for that type of liner.

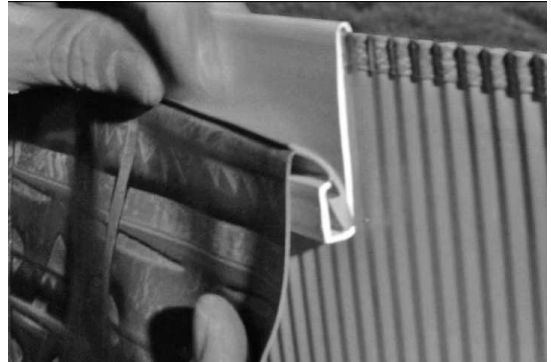

□ 5.2.2 - A3: Proceed for the rest of the wall.



*** NOTE : Do not install the liner on both sides simultaneously. Be careful not to create wrinkles. Install the liner from one point to the end by following one direction.**

□ 5.2.2 - A4: Before proceeding further, check the gap between the top wall channels, it should be roughly similar to the bottom wall channels.

Step 5.2.2 - B: Overlapping liners installation

If you don't have this type of liner, jump to the previous section!

□ **5.2.2 - B1:** Remove the **top wall channels** one section at a time.



□ **5.2.2 - B2:** Overlap the liner at the top of the wall and hold it in place by inserting the plastic coping.



□ **5.2.2 - B3:** Install the top wall channels on the wall.

□ **5.2.2 - B4:** To prevent the liner from being visible on the outside of the pool, fold it enough to be hidden by the top seats.



□ 5.2.2 - B5: Proceed for the rest of the wall.

*** NOTE 1 : Do not install the liner on both sides simultaneously. Be careful not to create wrinkles. Install the liner from one point to the end by following one direction.**

Liner adjustment and filling the pool

□ 5.2.3: To ease the installation of the liner, you can use a vacuum cleaner by blocking the skimmer with adhesive tape.



□ 5.2.4: Insert the hose of a vacuum cleaner a few feet into the water return. This will have the effect of pumping out the air and ease the process of removing the creases and wrinkles.



□ 5.2.5: To help the liner to fit the pool and remove the wrinkles, place your self along the wall, and with both feet do a slight jump a few inches backward while the vacuum cleaner is in operation. Do this all around the pool where there are wrinkles.

Do not forget the remove your shoes!



Filling the pool

□ 5.2.6: Start filling the pool by using a slow stream of water.

□ 5.2.7: As the water rises, remove any remaining creases by pushing the excess material towards the sides of the pool wall.

□ 5.2.8: Before proceeding further, check the gaps between the top wall channels. These gaps should be roughly similar to the gaps of the bottom wall channels.

□ **5.2.9:** Continue filling the pool until the cove is completely covered.

For overlap liners: While filling the pool, gently pull up the excess liner to the top of the pool wall just along the cove area. Set the liner firmly into the **top wall channels**.

IMPORTANT REMINDER!!

- Pull the liner firmly but gently. **DO NOT PULL THE LINER COVERED BY WATER.**
- Avoid sharp tugs or pulling the liner by its seams.
- Do not damage the cove.
- Equally, distribute any excess in the liner circumference around the top of the pool.
- Use the top wall channels to hold the liner in position.
- Ensure that the bottom of the liner is smooth and free of creases.

STEP 6: TOP SEAT AND SEAT CAP INSTALLATION

RESIN TOP PLATE

□ 6.1: Install the top junction plate on the metal post. Secure with three screws.

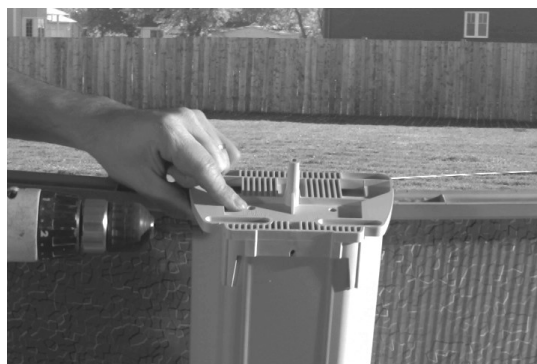

TOP SEAT INSTALLATION

□ 6.2: Place yourself behind a post and install the top seat to your right, then place another top seat on your left. There is a tab on the left seat which leans on the right seat. Place the screws slightly.

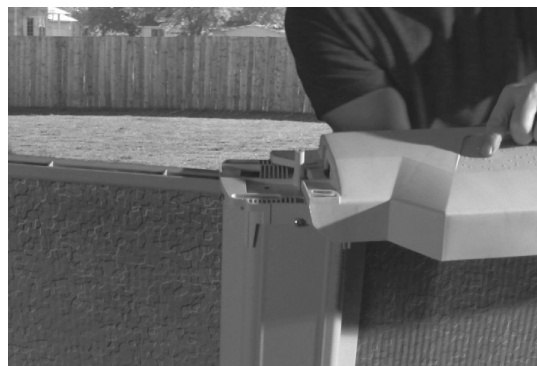
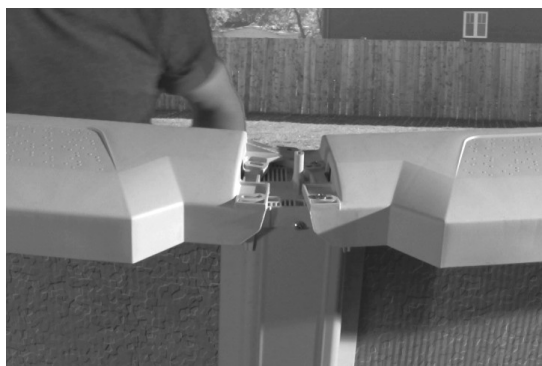

□ 6.3: Partially insert 1" screws on the top.



□ 6.4: Evenly distribute the space between the top seats to center them between the posts.

□ 6.5: When all the top seats are in place, fill the pool up to 2 feet beneath the edge of the pool before continuing.

□ 6.6: Make sure to level the two axes of the posts by pushing slightly inwards before tightening the screws permanently. Install all the necessary equipment (skimmer, filter, etc.) by following the directives of the manufacturers.

SEAT CAP INSTALLATION

□ 6.7: Insert the rear part of the seat cap (inside the pool) on the top of a post.

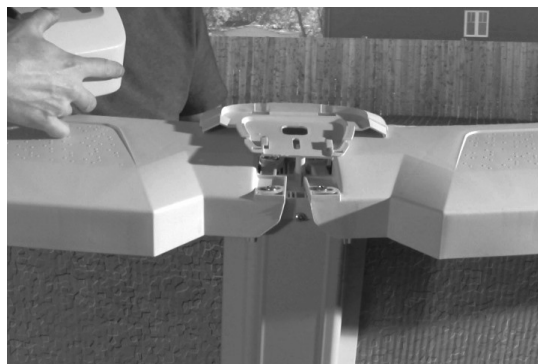

□ 6.8: Slide the front part of the seat cap into the grooves of the seat cap rear part.



□ 6.9: When everything is in place, insert a screw in the hole on the top of the front seat cap.



□ 6.10: Place and press firmly on the seat cap cover.

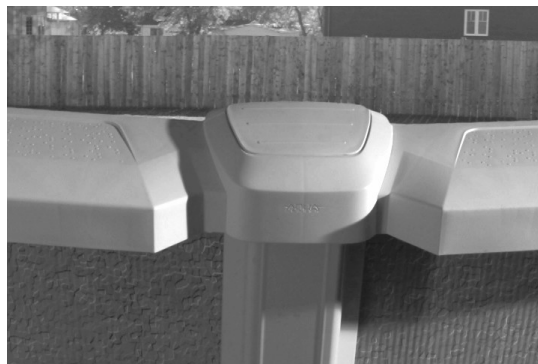
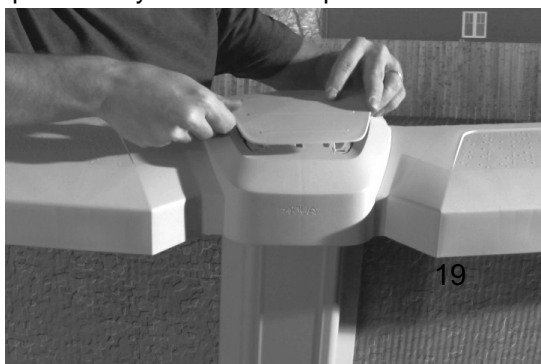



FINAL INSTALLATION TIPS

When installing a thru-the-wall skimmer, follow the instructions of the manufacturer. It is essential that there is no leakage of water at either of the openings. If water is allowed to drip down the metal wall of the pool, it will cause the wall to eventually deteriorate and split. At the slightest sign of corrosion, you must sand down this area and paint it. It is a good idea to silicone edge of wall at skimmer opening. Gasket is used directly over steel an aluminum wall.

Be prepared to chlorinate your water within 24 hours of filling to prevent algae and bacterial growth. If you are using well water or water with high mineral content, consult your pool dealer for proper preventative action.

DO NOT PUT POOL CHEMICALS DIRECTLY INTO THE WATER. ALL CHEMICALS MUST BE THOROUGHLY DISSOLVED IN WATER, AND THEN Poured INTO THE POOL. IF CHLORINE IS NOT DISSOLVED, IT WILL BLEACH LINER AND MAKE PINHOLES IN THE LINER. IF WATER IS DRAINED AT ANY TIME, LINER MAY SHRINK AND BECOME UNUSABLE WITH NO RECOURSE TOWARDS THIS COMPANY. REMOVAL OF WATER WILL VOID WARRANTY.

POOL MAINTENANCE

Small repairs and punctures in your liner may be easily repaired using underwater repair kits available at your local dealer. Scratches on your pool wall and frame must be touched up with anti-rust enamel paint. Keep your pool wall and frame clean. Wash periodically with a mild soap solution (no abrasives). Use a clean non-yellowing household wax on all metal components.

Quickly wash away any deposits of pool chemicals which land on the frame of your pool.

Since metal are subject to wear and/or corrosion, a strict periodic inspection schedule should be maintained and followed. If any corrosion is found, IMMEDIATE CORRECTIVE ACTION MUST BE TAKEN. Wire brush all rust and add a coat of enamel primer followed by a coat of color matching anti-rust enamel paint. The skimmer area is one particular area that must be carefully inspected. If any corrosion is allowed to continue, failure of the pool structure may follow which could result in excessive property damage as well as bodily harm.

AQUA LOUNGE MAINTENANCE (If you have this option)

To fully take advantage of your pool entry system AQUA LOUNGE, some precautions must be taken. It is important that all decks, patios or any arrangement surrounding the AQUA LOUNGE be ventilated. Intense heat on the fiberglass could discolor the surface. In addition, wax application on the surface will assure you to keep the shinny appearance and prevent dirt to stick on the surface. Some cleaning products can be used to clean watermarks. Check with your AQUA LEADER dealer.

WINTERIZING YOUR POOL

All of our liners are designed to be left up all winter, but nonetheless are subject to the warranty of the liner being purchased. Continue to chlorinate and filter your water until the pool is closed down. Before closing down your pool for the winter, you must make a complete inspection of the pool. Check all the connections to make sure they are tight and in good condition. Check to see that the liner is snugly held in place over the wall. If there is any indication of rust and/or deterioration in any part, you must correct the situation immediately. During the winter, the pool is subject to more stress than in the summer and any breakage that is caused by incorrect winterizing will void the warranty.

Lower the level of water to about 18 in. (45 cm) below the skimmer holes. Throughout the winter, you must check this level, as it must not reach the skimmer holes at any time during the winter. Because of rain and snow, adjustments will become necessary. Never leave the pool stand empty without any water in it as it will be subject to wind damage.

If your skimmer is supplied with a winter plate and cap, follow the same steps as above. It is essential that no water be allowed to run down the wall for any period, as it will cause the wall to deteriorate. If your skimmer did not come with the winter plate, it is available at a nominal charge at your dealer and is recommended. Even in the summer, the SKIMMER MUST NOT BE ALLOWED TO LEAK INSIDE OR OUTSIDE THE WALL, as this will cause the wall to deteriorate and possibly break. See your dealer for more information.

YOU HAVE BEEN GIVEN WARNING LABELS, WHICH MUST BE PLACED ON THE LINER AND TOP SEAT. YOU HAVE ALSO RECEIVED A LARGER SIGN, WHICH IS TO BE PLACED ON THE OUTSIDE WALL NEXT TO THE ENTRY OF THE POOL.

IMPORTANT WINTER RULES

After the pool has been winterized and ALL steps carefully followed, the following checks and procedures MUST BE strictly followed during fall, winter and spring seasons.

YOUR POOL WARRANTY WILL BE VOIDED IF THE POOL HAS BEEN IMPROPERLY WINTERIZED AND THE FOLLOWING PROCEDURES NOT STRICTLY ADHERED TO. POOLS, WHICH HAVE BEEN INCORRECTLY WINTERIZED, WILL COLLAPSE UNDER THE TREMENDOUS PRESSURES EXERTED BY ICE AND SNOW.

A pool that is left up during the freezing temperatures MUST NOT BE ALLOWED TO LEAK. To determine if your pool is leaking, mark the liner at the water level and very closely observe the water level in the pool for a period of 10 days to 2 weeks after the pool is closed for the winter. Any rain during this period may compensate for any undetected water leakage. Therefore, the observation period may be extended to find any leaks. All leaks must be found and immediately repaired. Any water leakage, which goes undetected or occurs after the top surface is frozen will allow the frozen surface to settle and may damage the pool liner, wall and framework.

NOTE: It is not uncommon for a leak to develop during rigorous summer usage and go undetected. What is thought to be water loss due to evaporation or spillage may be caused by a small leak. Look for persistent wet areas around the pool and investigate. Maintain a strict leak inspection schedule throughout the fall, winter and spring months. Spring thawing, which frequently leads to ground heaving, can be especially dangerous if care is not taken. Maintain a strict inspection in the wall skimmer housing to see that water is not leaking at the gasket. If the skimmer was not removed, water should not be allowed to build up in the skimmer housing as the water will freeze and crack the housing and cause possible damage to the wall. Consult your pool dealer for the proper winter chemicals to be used for quick spring start up.



During the course of the winter, the liner may pull out of its coping due to no fault of the MANUFACTURER OR THE POOL INSTALLER. Due to freezing and thawing of the ground, the ground sometimes sinks and the liner with the weight of ice or water will sink, pulling the liner out of its coping. DO NOT PERMIT ICE SKATING, as this may damage the liner. IF THESE INSTRUCTIONS ARE NOT FOLLOWED CAREFULLY, YOUR WARRANTY WILL BE VOIDED WITH POSSIBLE PERMANENT DAMAGE TO YOUR POOL.

RULES FOR SAFE POOL USE

You have purchased a family pool of superior quality and durability. Your Aqua Leader warranty guarantees you years of enjoyment under normal use and care. (See warranty for complete details and conditions.) As an owner, you are responsible for the protection of those who swim in your pool. We urge you to follow these basic safety rules:

Safety equipment

- A light and strong pole not less than 12 feet (3.66m) long with blunt ends located in close proximity of the pool.
- A life ring preserver with a throwing rope attached to it.
- Emergency numbers near the pool and on the telephone nearest to the pool. (Police, fire and rescue unit, physician, ambulance, and hospital).

Pool owner safety rules

- Never dive or jump from the top rail of the pool. Your pool is designed for swimming and wading, not jumping or diving.
- Do not walk, sit or stand up on the pool top rails.
- Never allow children to swim without supervision.
- Never swim alone.
- Always remove the pool ladder, or raise the safety ladder when the pool is not in use.
- If you eat, wait at least one hour before you go swimming.
- Do not allow family pets in the pool.
- Do not allow any horseplay or roughness around the pool.
- Do not throw objects (e.g.: sticks, stones) into the pool.
- Keep all electrical appliances away from the pool.
- Keep all glass or metal objects away from the pool.
- To avoid the spread of bacteria or infection do not allow sick people in the pool.
- Do not swim when there are risks of lighting. Thunderstorms may endanger swimmers.

Unfortunately, many pool owners wait until an accident has occurred before setting guidelines. Establish your rules before the first person steps into the pool. If possible, make sure that everyone using the pool has some basic training in water safety and basic rescue methods. Some associations publish booklets about "basic rescue and water safety" that provides information on assisting a swimmer in difficulty, artificial respiration, first aid for swimmers, family water safety, and several other subjects. We strongly recommend you get one.

The company reserves the right to modify or alter any construction specifications without notice.
Manufactured by TRENDIUM POOL PRODUCTS INC (Member of the Wilbar Group) 7050 St-Patrick Street,
LaSalle, Quebec H8N 1V2 CANADA.

ANNEX - PARTS LIST - LIBERTY

Description	Part number	12'	15'	18'	21'	24'	27'	30'
A- Top wall channel								
12', 15'	1071507160000	8	10	-	-	-	-	-
18'	1071807160000	-	-	12	-	-	-	-
21'	1072107160000	-	-	-	14	-	-	-
24'	1072407160000	-	-	-	-	16	-	-
27'	1072707160000	-	-	-	-	-	18	-
30'	1073007160000	-	-	-	-	-	-	20
B- Bottom wall channel								
12', 15', 18'	10815XX000000	8	10	12	-	-	-	-
21', 24', 27'	10824XX000000	-	-	-	14	16	18	-
30'	10830XX000000	-	-	-	-	-	-	20
C- Steel wall								
Steel wall (Length hole-to-hole)	109_ _ _ _XX00YYZZ	37' 8"	47' 1"	56' 7"	66'	75' 5"	84' 10"	94' 3"
D-Liner								
Vinyl liner (hooks)		1	1	1	1	1	1	1
Vinyl liner (Overlap)		1	1	1	1	1	1	1
E- Support posts								
Support post	102YY3500ZZ	8	10	12	14	16	18	20
F- Top seat								
Curved top seat	101XX350000	8	10	12	14	16	18	20
G- Seat cap								
Seat cap (Front and back part)	103XX350000	8	10	12	14	16	18	20
H- Seat cap plate								
Seat cap plate	103XX350030	8	10	12	14	16	18	20
I- Top plate								
Post top plate	111YY350000	8	10	12	14	16	18	20
J- Bottom plate								
Post bottom plate	112YY350000	8	10	12	14	16	18	20
K- ¾ inch screw								
Stainless steel screw 12 x ¾ inch	2PPS124	72	90	108	126	144	162	180

___ (Diameter)= 0012, 0015, 0018, 0021, 0024, 0027, 0030, 0033
XX (Color)= 02(pearl), 07(sand), 09(champagne), 33(grey)
YY (Wall)= 41(Azure)
ZZ (Height)= 02(52"), 04(54"), 62(52" S/S), 64(54" S/S)

Diameter table	
Pool diameter	Real radius
12' (3,64 m)	6' (1,82 m)
15' (4,55 m)	7' 6" (2,27 m)
18' (5,45 m)	9' (2,73 m)
21' (6,36 m)	10' 6" (3,18 m)
24' (7,27 m)	12' (3,64 m)
27' (8,18 m)	13' 6" (4,09 m)
30' (9,09 m)	15' (4,55 m)

EXPLODED VIEW

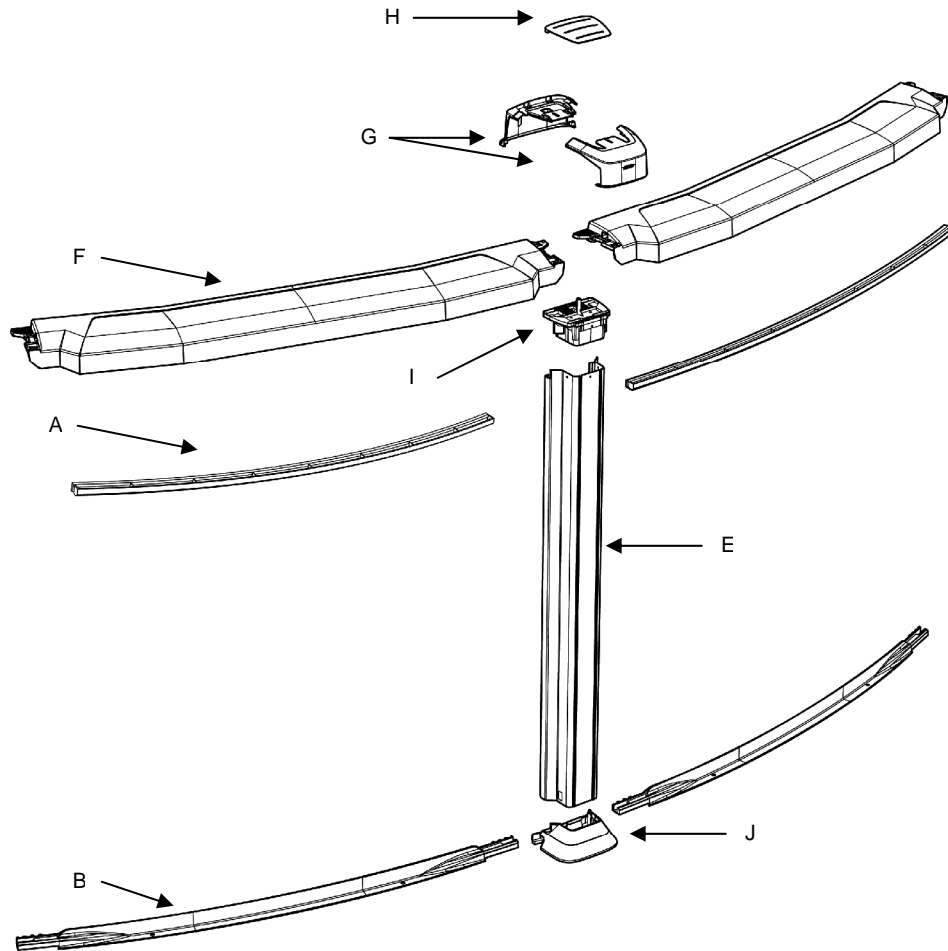

Manufactured by Trendium Pool Products Inc.,(member of the Wilbar Group) 7050 St-Patrick Street, LaSalle, Quebec H8N 1V2 CANADA. Aqua Leader is a brand of the Wilbar Group. The dimensions, weights, illustrations and other specifications are approximate. The company reserves the right to modify and/or discontinue without notification any feature in any pool model.

©Copyright 2009
4FIA407